

Name the Simple Machine

KEY

By: Terry Dugger

Name the simple machine.



1. Incline plane

Name the simple machine.



2. Lever

Name the simple machine.

3. _Wheel and
axle_

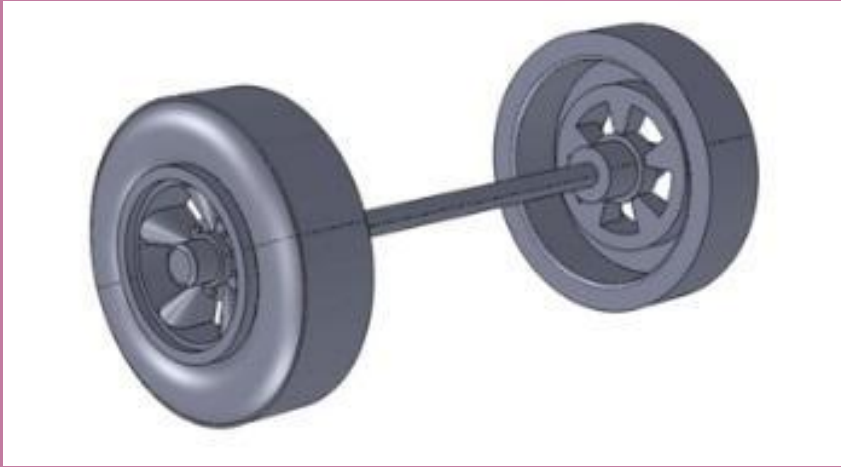

Name the simple machine.



4. Pulley

Name the simple machine.



5. Lever

Name the simple machine.



6. Screw

Name the simple machine.



7. Lever

Name the simple machine.

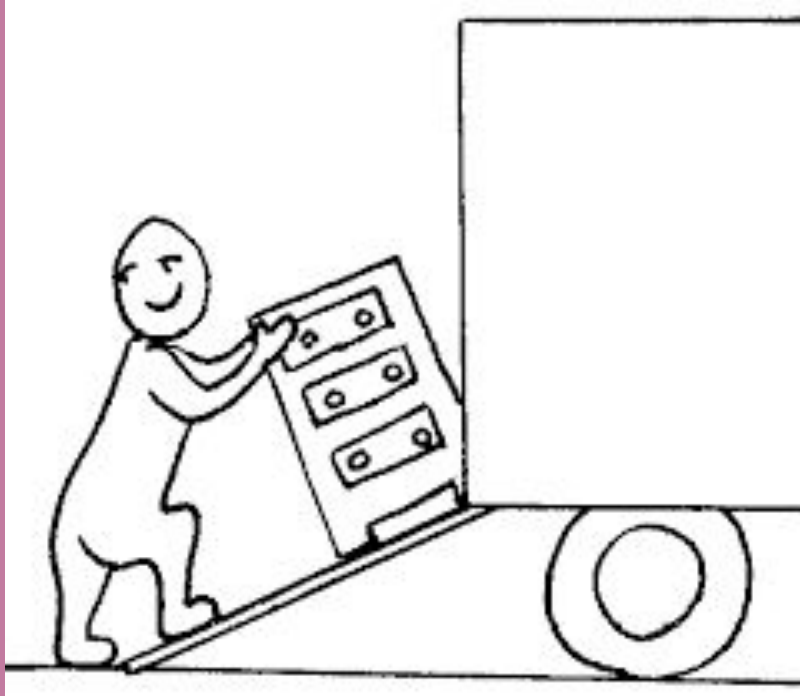

8. Incline plane

Name the simple machine.

9. Lever

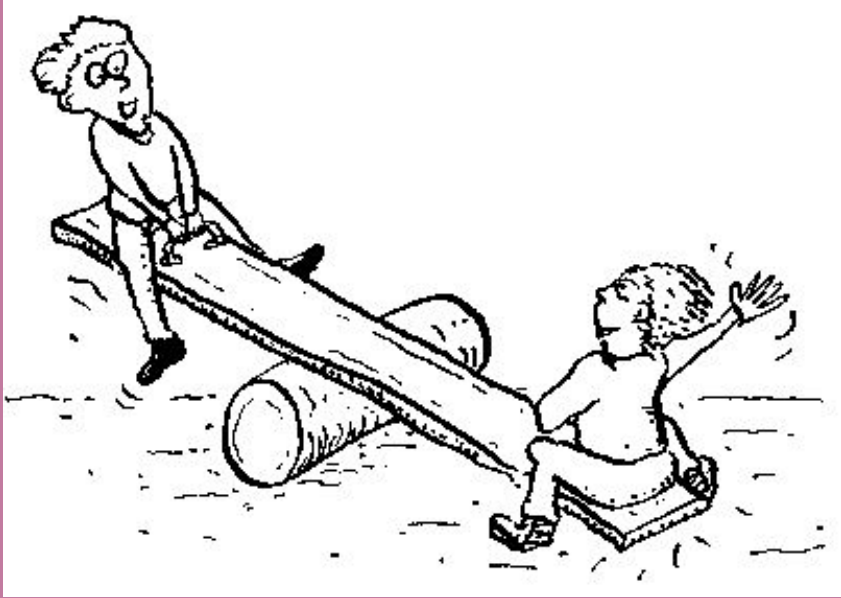

Name the simple machine.

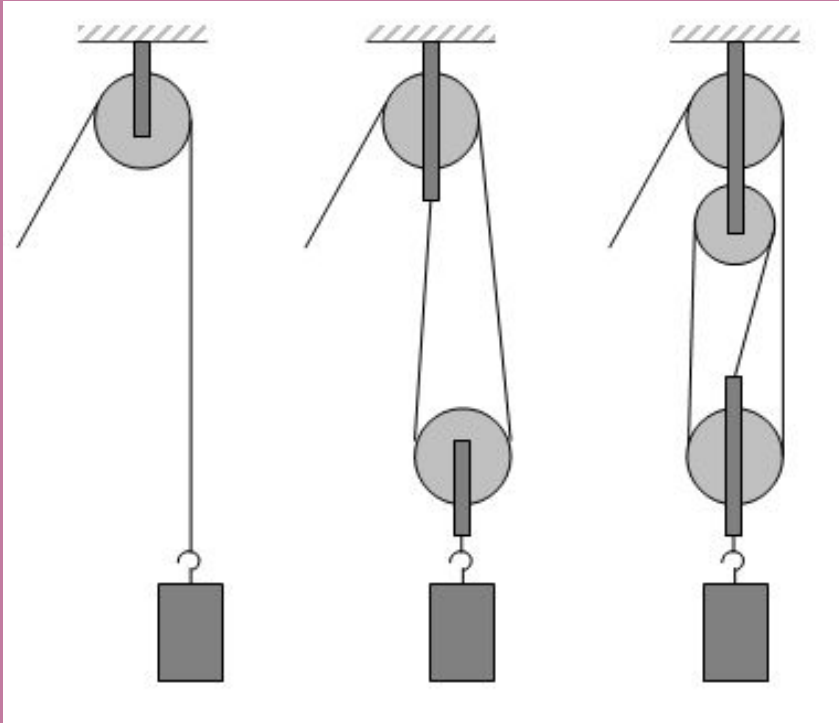

10. Pulley

Name the simple machine.

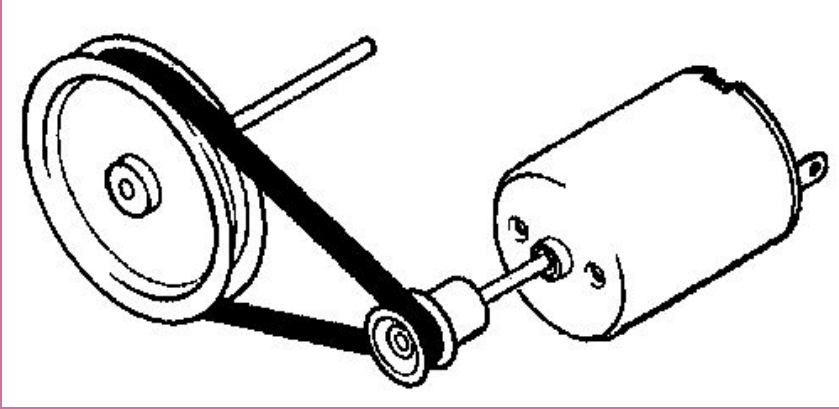

11. _Wheel and
axle_

Name the simple machine.



12. Pulley

Name the simple machine.

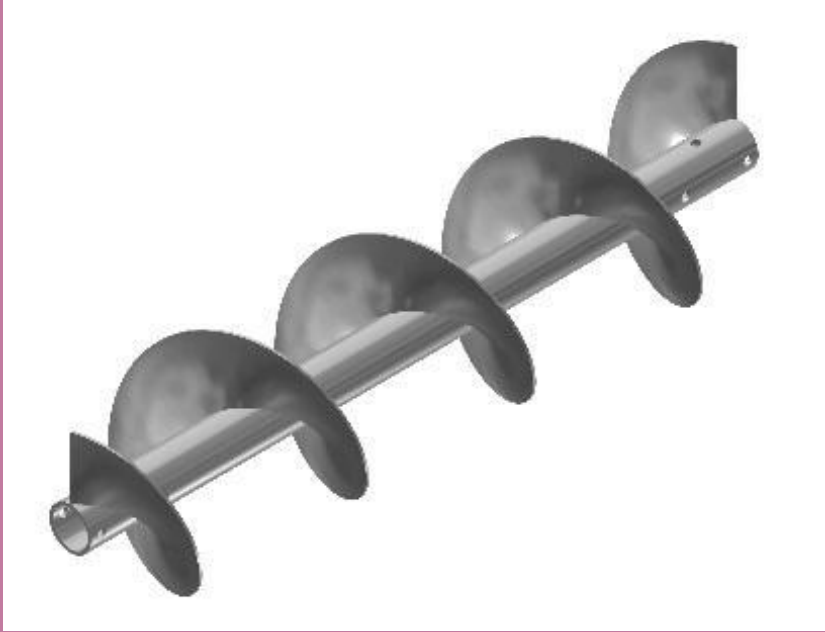

13. Screw

Name the simple machine.

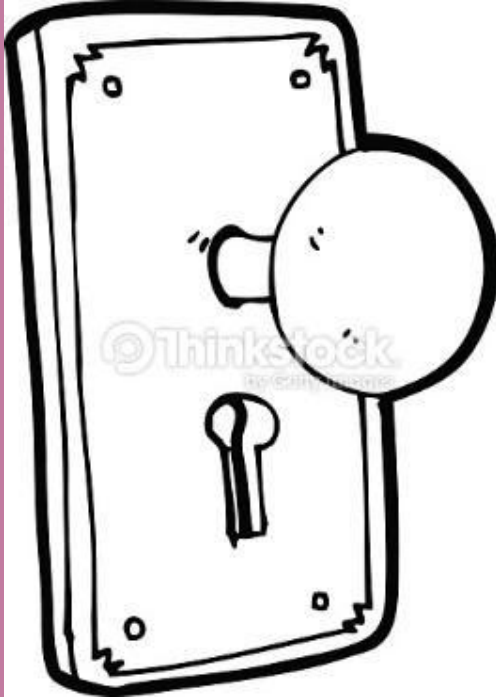

14. _Wheel and
axle_

Name the simple machine.

15. Lever

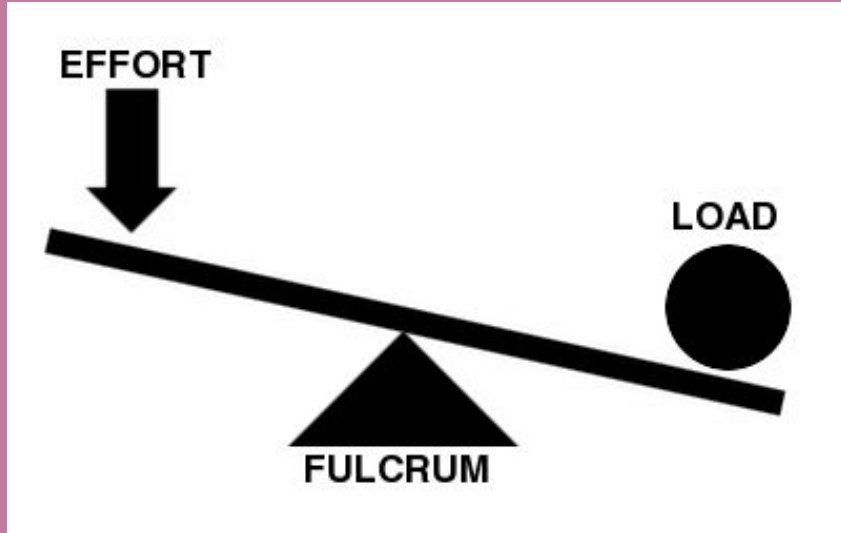

Name the simple machine.



16. _Wheel and
Axle_

Name the simple machine.



17. Incline plane

Name the simple machine.

18. Pulley

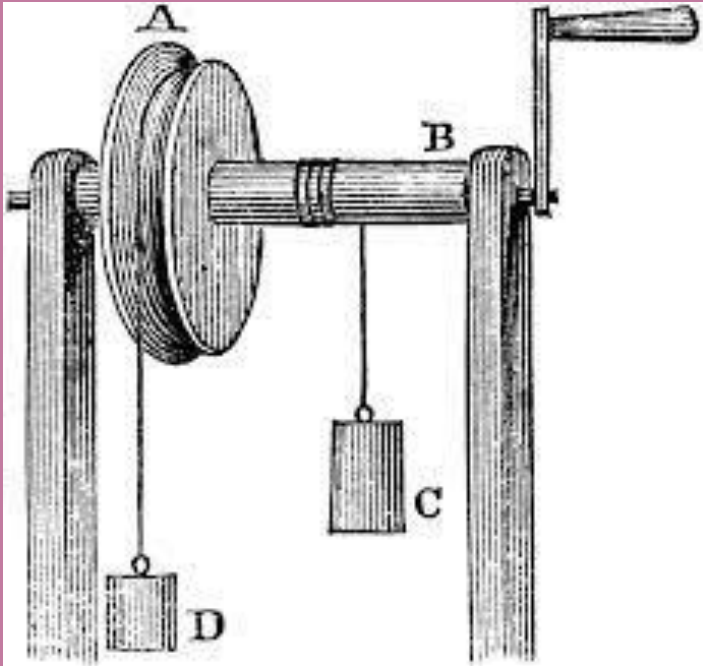

Name the simple machine.



19. _Wheel and
axle_

Name the simple machine.

20. Pulley



Name the simple machine.

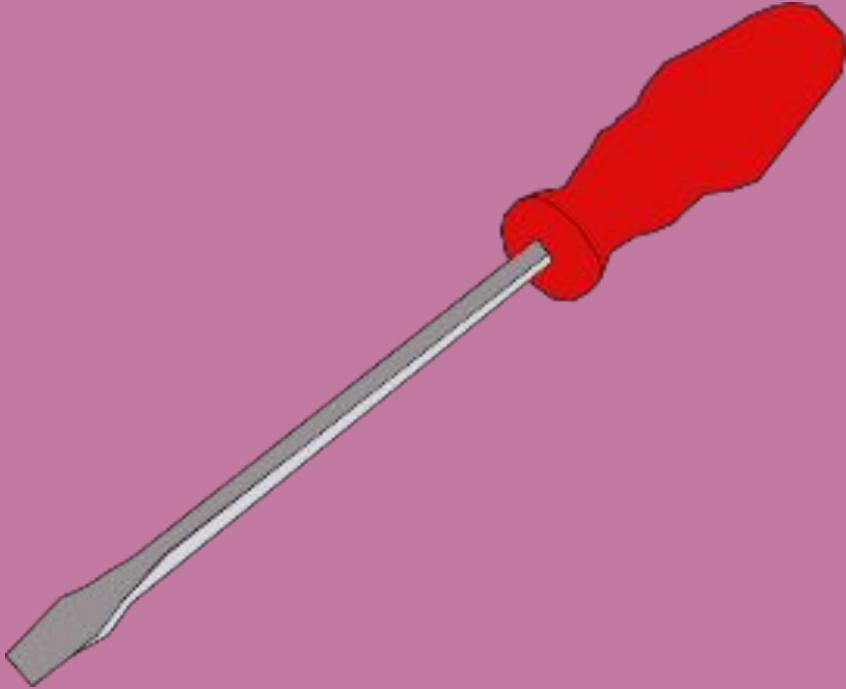

21. _Wheel and
axle_

Name the simple machine.

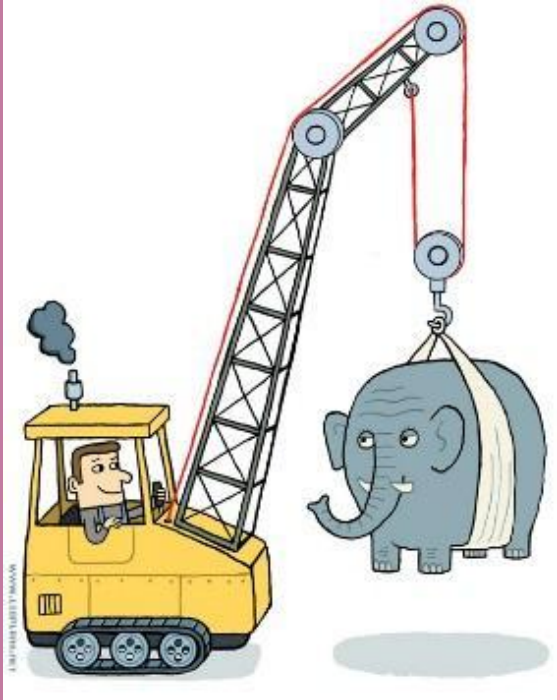

22. Pulley

Name the simple machine.

23. Incline plane

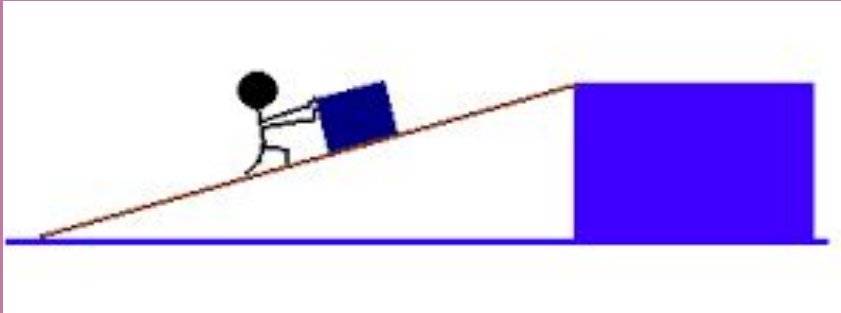

The End